



TRIGO T

Silla manual activa plegable
con reposapiés extraíbles
multi-adjustable
con gran rango de opciones



			P.V.P.
S = Standard O = opción sin coste extra □ = opción con coste extra			1.800,00 €

DIMENSIONES ASIENTO

Ancho (cm)	Profundidad (cm)											
	32	34	36	38	40	42	44	46	48	50		
30	O	O	O	O	O	O	O	O	O	O	-	Cruceta simple Peso máx usuario: 70 kg
32	O	O	O	O	O	O	O	O	O	O	-	
34	O	O	O	O	O	O	O	O	O	O	-	
36	-	-	O	O	O	O	O	O	O	O	-	
38	-	-	O	O	O	O	O	O	O	O	-	Cruceta 1,5 Peso máx usuario: 130 kg
40	-	-	O	O	O	O	O	O	O	O	-	
42	-	-	O	O	O	O	O	O	O	O	-	
44	-	-	O	O	O	O	O	O	O	O	-	
46	-	-	O	O	O	O	O	O	O	O	-	Doble cruceta Peso máx usuario: 130 kg
48	-	-	O	O	O	O	O	O	O	O	-	
50	-	-	O	O	O	O	O	O	O	O	-	

ancho mínimo total con protectores standard y 0° de caída: Ancho de asiento + 16 cm

ALTURA DELANTERA ASIENTO (en mm)

	380	390	400	410	420	430	440	450	460	470	480	490	500	510
rueda 3"	O	O	O	O	O	O	O	O	O	O	O	O	O	O
rueda 4"		O	O	O	O	O	O	O	O	O	O	O	O	O
rueda 5"			O	O	O	O	O	O	O	O	O	O	O	O
rueda 6"				O	O	O	O	O	O	O	O	O	O	O

ALTURA TRASERA ASIENTO (en mm)

	315	325	335	345	355	365	375	385	395	405	415	425	435	445	455	465	475	485	495	505	515
rueda 18"	O	O	O	O	O	O	O	O	O	O	O	O	O	O	O	O	O	O	O	O	O
rueda 20"			O	O	O	O	O	O	O	O	O	O	O	O	O	O	O	O	O	O	O
rueda 22"				O	O	O	O	O	O	O	O	O	O	O	O	O	O	O	O	O	O
rueda 24"					O	O	O	O	O	O	O	O	O	O	O	O	O	O	O	O	O
rueda 26"						O	O	O	O	O	O	O	O	O	O	O	O	O	O	O	O

PROTECTORES

B82S fijo	Protector de ropa fijo - aluminio	O	-	img 001
B82-C fijo	Protector de ropa fijo - carbono	□	380,00 €	img 001
B82 fijo	Protector de ropa antisalpicaduras fijo - aluminio	□	54,00 €	img 002
BI5	Reposabrazos ajustable en altura	□	75,00 €	img 003
TUBE	Reposabrazos tubular (abatible) <i>incompatible con respaldo regulable o plegable</i>	□	90,00 €	img 004
B82S-A	Protector de ropa extraíble - aluminio	□	90,00 €	img 005
B82S-C	Protector de ropa extraíble - carbono	□	340,00 €	img 005
B82SL-A	Protector de ropa extraíble LARGO - aluminio	□	105,00 €	img 006
B82-A	Protector de ropa antisalpicaduras extraíble - aluminio	□	120,00 €	img 007
B82L-A	Protector de ropa antisalpicaduras extraíble LARGO - aluminio	□	135,00 €	img 008
B82-C	Protector de ropa antisalpicaduras extraíble - carbono	□	380,00 €	img 009





img 001



img 002

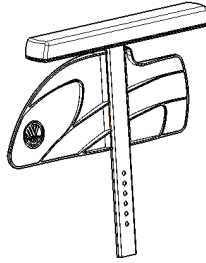

img 003

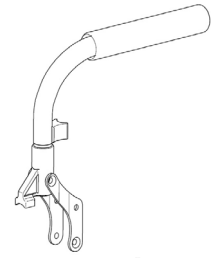

img 004

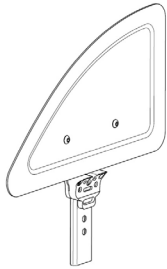

img 005

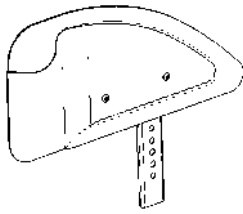

img 006

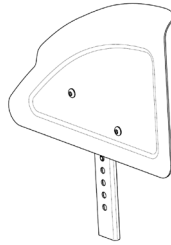

img 007

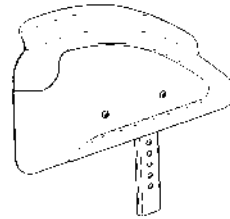

img 008

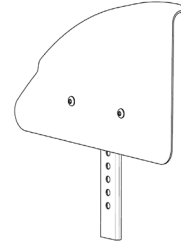

img 009

REPOSAPIÉS

B06 70°	Reposapiés abatible y extraíble, ajustable en ángulo - tubo a 70°	<input type="radio"/>	-	img 011
B06 80°	Reposapiés abatible y extraíble, ajustable en ángulo - tubo a 80°	<input type="radio"/>	-	img 012
B06 90°	Reposapiés abatible y extraíble, ajustable en ángulo - tubo a 90° INCOMPATIBLE CON RUEDAS DELANTERAS DE 6"	<input type="radio"/>	-	img 013
BA06 70°	Reposapiés abatible y extraíble, ajustable en ángulo - 5 cm más corto - tubo a 70°	<input type="radio"/>	-	img 014
BA06 80°	Reposapiés abatible y extraíble, ajustable en ángulo - 5 cm más corto - tubo a 80°	<input type="radio"/>	-	img 014
BA06 90°	Reposapiés abatible y extraíble, ajustable en ángulo - 5 cm más corto - tubo a 90° INCOMPATIBLE CON RUEDAS DELANTERAS DE 6"	<input type="radio"/>	-	img 014

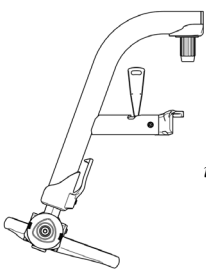

img 011

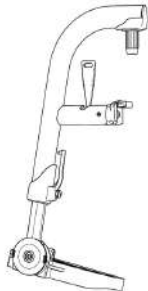

img 012

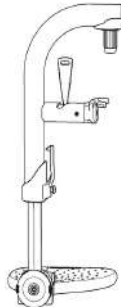

img 013

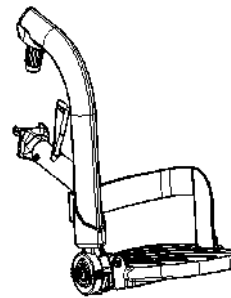

img 014

Longitud de pierna (LLL) *distancia entre hueco poplíteo y arco plantar*

22 cm	<input type="radio"/>
24 cm	<input type="radio"/>
26 cm	<input type="radio"/>
28 cm	<input type="radio"/>
30 cm	<input type="radio"/>
32 cm	<input type="radio"/>
34 cm	<input type="radio"/>
36 cm	<input type="radio"/>
38 cm	<input type="radio"/>
40 cm	<input type="radio"/>
42 cm	<input type="radio"/>
44 cm	<input type="radio"/>
46 cm	<input type="radio"/>

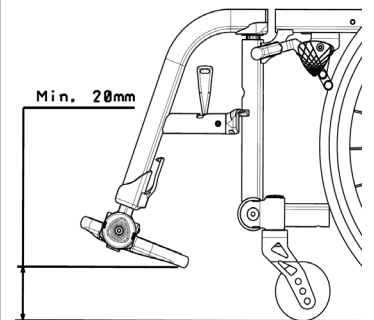

La longitud de pierna debe ser al menos 20mm menos que la altura de asiento delantera seleccionada



COLORES (chasis)					
Parte delantera		mate		brillo	
C4	Rojo	<input type="radio"/>	<input type="radio"/>	-	
C5	Negro	<input type="radio"/>	<input type="radio"/>	-	
C8	Amarillo	<input type="radio"/>	<input type="radio"/>	-	
C29	Plateado	<input type="radio"/>	<input type="radio"/>	-	
C53	Naranja	<input type="radio"/>	<input type="radio"/>	-	
C55	Inox	<input type="radio"/>	<input type="radio"/>	-	
C56	Azul metálico	<input type="radio"/>	<input type="radio"/>	-	
C59	Champagne	<input type="radio"/>	<input type="radio"/>	-	
C71	Azul abisal metálico	<input type="radio"/>	<input type="radio"/>	-	
C72	Rojo cereza metálico	<input type="radio"/>	<input type="radio"/>	-	
C73	Verde metálico	<input type="radio"/>	<input type="radio"/>	-	
C76	Blanco	<input type="radio"/>	<input type="radio"/>	-	
C79	Azul celeste	<input type="radio"/>	<input type="radio"/>	-	
C85	Verde brillante	<input type="radio"/>	<input type="radio"/>	-	
C87	Calabaza	<input type="radio"/>	<input type="radio"/>	-	
C88	Oro	<input type="radio"/>	<input type="radio"/>	-	
C89	Cobre	<input type="radio"/>	<input type="radio"/>	-	
	Color personalizado	<input type="checkbox"/>	<input type="checkbox"/>	225,00 €	
Parte trasera					
	Negro mate		S	-	
	Color personalizado	<input type="checkbox"/>		225,00 €	
ASIENTO					
	Nylon lona fija		S	-	
	Nylon ajustable en tensión	<input type="radio"/>		-	
	Cojín espuma 5cm	<input type="checkbox"/>		60,00 €	
	Cojín de 5cm con capa viscolástica	<input type="checkbox"/>		120,00 €	
B24D	Cojín de 6 cm partido para plegado	<input type="checkbox"/>			
Cojines VICAIR					
	Cojín VICAIR ADJUSTER O2 6 cm	<input type="checkbox"/>		535,00 €	
	Cojín VICAIR ADJUSTER O2 10 cm	<input type="checkbox"/>		535,00 €	
	Cojín VICAIR VECTOR O2 6 cm	<input type="checkbox"/>		599,00 €	
	Cojín VICAIR VECTOR O2 10 cm	<input type="checkbox"/>		599,00 €	
	Cojín VICAIR ACTIVE O2 6 cm	<input type="checkbox"/>		575,00 €	
	Cojín VICAIR ACTIVE O2 10 cm	<input type="checkbox"/>		575,00 €	

O₂
LAVABLES A MÁQUINA
100% TRANSPIRABLE

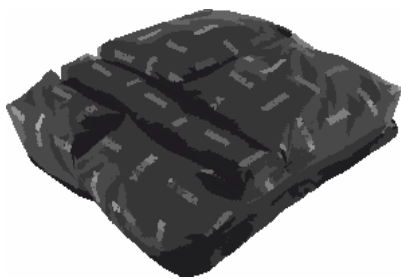

ADJUSTER O2



VECTOR O2

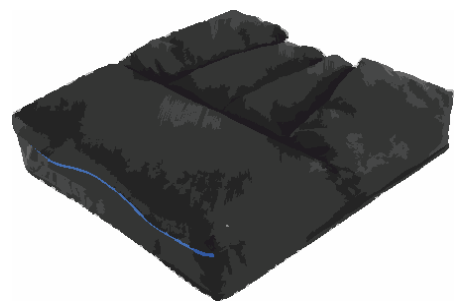

ACTIVE O2

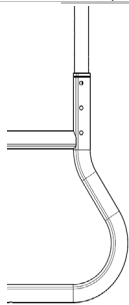
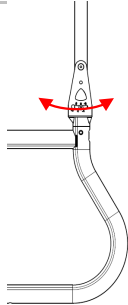
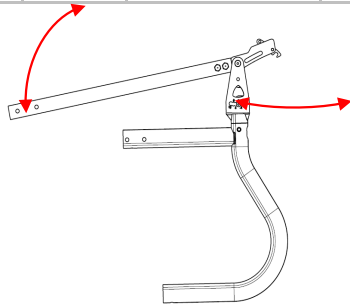
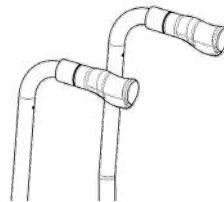
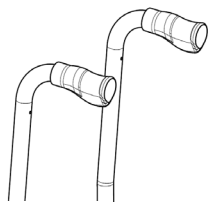
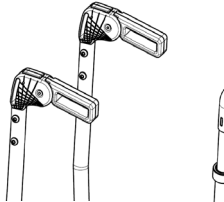
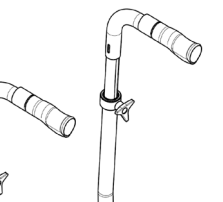
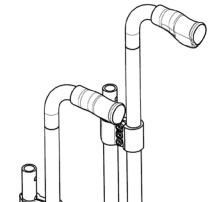
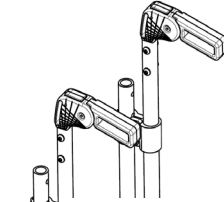

RESPALDO											
Estructura											
	Respaldo fijo								○	-	img 021
	Respaldo reclinable (82° - 102°) ajuste mediante botón, ángulo standard: 90°								□	210,00 €	img 022
	Respaldo reclinable & plegable (82° - 102°) ajuste mediante botón, ángulo standard: 90°								□	252,00 €	img 023
<p>No disponible para anchos 30-34 cm Consulta la tabla de compatibilidades</p> <p>No disponible para anchos 30-34 cm Consulta la tabla de compatibilidades</p>											
											
	<i>img 021</i>										
											
	<i>img 022</i>										
											
	<i>img 023</i>										
Tapizado											
	Nylon - ajustable en tensión con reflectantes traseros								○	-	
	Net - ajustable en tensión con reflectantes traseros								○	-	
	3D - ajustable en tensión con reflectantes traseros								○	-	
	Bolsillo trasero								□	30,00 €	
Altura de respaldo											
	Tipo de Puños de empuje (ver abajo)	no PH	PH 01	PH 02	PH 03	PH 04	PH 05	PH 06			• : compatible Δ : compatible solo con respaldo fijo - : incompatible
Altura fija	25 cm	Δ	Δ	Δ	Δ	-	Δ	Δ	○	-	
	27 cm	Δ	Δ	Δ	Δ	-	Δ	Δ	○	-	
	29 cm	Δ	Δ	Δ	Δ	-	Δ	Δ	○	-	
	31 cm	Δ	Δ	Δ	Δ	-	Δ	Δ	○	-	
	33 cm	Δ	Δ	Δ	Δ	-	Δ	Δ	○	-	
	35 cm	•	•	•	•	-	•	•	○	-	
	37 cm	•	•	•	•	-	•	•	○	-	
	39 cm	•	•	•	•	Δ	•	•	○	-	
	41 cm	•	•	•	•	Δ	•	•	○	-	
	43 cm	•	•	•	•	Δ	•	•	○	-	
	45 cm	•	•	•	•	Δ	•	•	○	-	
	47 cm	•	•	•	•	Δ	•	•	○	-	
Altura ajustable (3 tramos)	25 - 27,5 - 30 cm	Δ	Δ	Δ	-	-	Δ	-	□	30,00 €	
	30 - 32,5 - 35 cm	Δ	•	•	Δ	-	Δ	-	□	30,00 €	
	35 - 37,5 - 40 cm	•	•	•	•	-	•	-	□	30,00 €	
	40 - 42,5 - 45 cm	•	•	•	•	-	•	-	□	30,00 €	
	45 - 47,5 - 50 cm	•	•	•	•	-	•	-	□	30,00 €	
Puños de empuje											
no PH	Sin puños de empuje								○	-	no PH
PH 01	Puños fijos (12 cm)								□	15,00 €	PH 01
PH 02	Puños fijos cortos (8 cm)								□	15,00 €	PH 02
PH 03	Puños plegables								□	150,00 €	PH 03
PH 04	Ajustables en altura telescópicos								□	45,00 €	PH 04
PH 05	Ajustables en altura con brida								□	150,00 €	PH 05
PH 06	Ajustables en altura con brida y plegables								□	240,00 €	PH 06
											
	<i>PH 01</i>										
											
	<i>PH 02</i>										
											
	<i>PH 03</i>										
											
	<i>PH 04</i>										
											
	<i>PH 05</i>										
											
	<i>PH 06</i>										



RUEDAS

Ruedas delanteras

diámetro	3"	4"	5"	6"	SELECCIONAR MISMO DIÁMETRO QUE EL ESCOGIDO PARA LA ALTURA DE ASIENTO DELANTERA		
standard negro	<input type="radio"/>	<input type="radio"/>	<input type="radio"/>	<input type="radio"/>	6" es incompatible con chasis 80° y 90°	-	img 031
transparente	<input type="radio"/>	<input type="radio"/>	<input type="radio"/>			-	img 032
alu - plata	<input type="checkbox"/>	<input type="checkbox"/>	<input type="checkbox"/>			60,00 €	img 033
alu - rojo	<input type="checkbox"/>	<input type="checkbox"/>	<input type="checkbox"/>			60,00 €	img 033
alu - azul	<input type="checkbox"/>	<input type="checkbox"/>	<input type="checkbox"/>			60,00 €	img 033
carbon		<input type="checkbox"/>	<input type="checkbox"/>			105,00 €	img 034
LED		<input type="checkbox"/>	<input type="checkbox"/>			60,00 €	img 035



img 031



img 032



img 033



img 034



img 035

RUEDAS

Ruedas traseras

18"	Estándar, rueda 18" con cubiertas Schwalbe Marathon Racer	<input type="checkbox"/>	210,00 €	img 041 + img 048	
20"	De diseño, rueda ligera 20" , radial, cubiertas Schwalbe Right Run negras	<input type="radio"/>	-	img 042 + img 046	
22"	De diseño, rueda ligera 22" , radial, cubiertas Schwalbe Right Run negras	<input type="radio"/>	-	img 042 + img 046	
24"	De diseño, rueda ligera 24" , radial, cubiertas Schwalbe Right Run negras	<input type="radio"/>	-	img 042 + img 046	
	De diseño, rueda ligera 24" , radial, cubiertas Schwalbe Marathon Plus	<input type="checkbox"/>	120,00 €	img 042 + img 047	
	Spirit 24" con buje de aluminio, radial, cubiertas Schwalbe Right Run negras	<input type="checkbox"/>	600,00 €	img 043 + img 046	
	Spirit 24" con buje de aluminio, radial, cubiertas Schwalbe Marathon Plus	<input type="checkbox"/>	650,00 €	img 043 + img 047	
	Spirit 24" buje rojo de aluminio, radial, cubiertas Schwalbe Right Run negras	<input type="checkbox"/>	600,00 €	img 043 + img 046	
	Spirit 24" buje rojo de aluminio, radial, cubiertas Schwalbe Marathon Plus	<input type="checkbox"/>	650,00 €	img 043 + img 047	
	Spirit 24" buje azul de aluminio, radial, cubiertas Schwalbe Right Run negras	<input type="checkbox"/>	600,00 €	img 043 + img 046	
	Spirit 24" buje azul de aluminio, radial, cubiertas Schwalbe Marathon Plus	<input type="checkbox"/>	650,00 €	img 043 + img 047	
	26"	De diseño, rueda ligera 26" , radial, cubiertas Schwalbe Right Run negras	<input type="checkbox"/>	75,00 €	img 042 + img 046
	De diseño, rueda ligera 26" , radial, cubiertas Schwalbe Marathon Plus	<input type="checkbox"/>	180,00 €	img 042 + img 046	
HEM2	Kit doble aro - rueda 24 x 1 3/8" INCOMPATIBLE CON INCLINACIÓN DE RUEDAS SOLO 0°	<input type="checkbox"/>	350,00 €	img 044	



img 046:



img 047:



img 048:



img 041



img 042



img 043



img 044

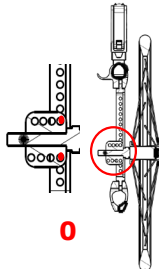
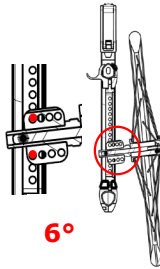

Caída (modificable por el usuario)				
0°			<input type="radio"/>	-
2°			<input type="radio"/>	-
4°			<input type="radio"/>	-
6°			<input type="radio"/>	-

Frenos				
	Freno de tiro (bloqueo tirando hacia atrás)	<input type="radio"/>	-	img F01
	Freno de empuje (bloqueo empujando hacia adelante)	<input type="radio"/>	-	img F02
	Freno deportivo	<input type="checkbox"/>	75,00 €	img F03
	Frenos de tambor (sólo con camber 0°) - ruedas 24 x 1 3/8" macizas grises	<input type="checkbox"/>	160,00 €	img F04
B40	Extensión de palanca de freno	<input type="checkbox"/>	30,00 €	img F05



img F01



img F02



img F03

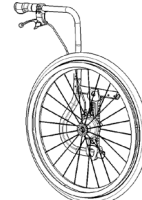

img F04



img F05

OPCIONES				
B31L	Porta-bastones izquierdo	<input type="checkbox"/>	30,00 €	img 051
B31R	Porta-bastones derecho	<input type="checkbox"/>	30,00 €	img 051
B78R	Rueda anti-vuelco derecha	<input type="checkbox"/>	60,00 €	img 052
B78L	Rueda anti-vuelco izquierda	<input type="checkbox"/>	60,00 €	img 052
B86	Ruedas tránsito	<input type="checkbox"/>	120,00 €	img 053
B90	Barra estabilizadora respaldo	<input type="checkbox"/>	30,00 €	img 054
L04 L	Control lateral IZQUIERDO	<input type="checkbox"/>	350,00 €	img 055
L04S L	Control lateral IZQUIERDO - PEQUEÑO	<input type="checkbox"/>	285,00 €	img 056
L04 R	Control lateral DERECHO	<input type="checkbox"/>	350,00 €	img 055
L04S R	Control lateral DERECHO - PEQUEÑO	<input type="checkbox"/>	285,00 €	img 056
B33	Cubre-aros de gel	<input type="checkbox"/>	120,00 €	img 057
	Cubre-radios	<input type="checkbox"/>	90,00 €	img 058
	Cubre-radios - PLANETA AZUL	<input type="checkbox"/>	160,00 €	img 059
	Cubre-radios - JUNGLA	<input type="checkbox"/>	160,00 €	img 060
	Cubre-radios - TRIGO 1	<input type="checkbox"/>	160,00 €	img 061
	Cubre-radios - TRIGO 2	<input type="checkbox"/>	160,00 €	img 062
V10	Cubretubo/protector Neopreno	<input type="checkbox"/>	75,00 €	img 063

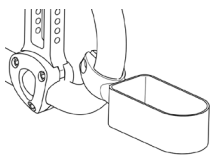

img 051

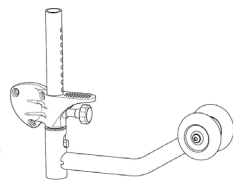

img 052

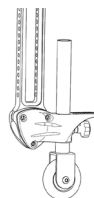

img 053

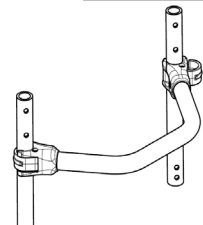

img 054

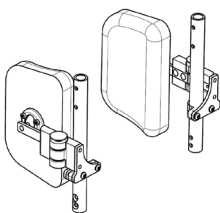

img 055

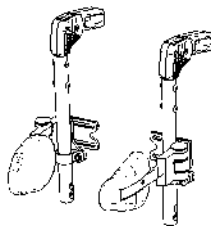

img 056



img 057

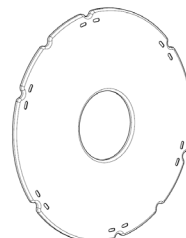

img 058



img 059





img 060



img 061



img 062



img 063

